

Insta Furniture



www.instabuilt.com



Contents

About us

- 03 - 04 Our History
- 05 - 06 Design Philosophy
- 07 - 08 Materials
- 09 - 10 Colors
- 11 - 12 Design with our modules

Our modules

- 15 - 16 Tall Modules
- 17 - 18 Lower Modules
- 19 - 20 Upper Modules
- 21 - 22 Rack Modules

Explore

- 11 - 12 Kitchens
- 13 - 14 Lower Modules
- 15 - 16 Upper Modules
- 17 - 18 Rack Modules

Our History

Modular homes were a new and exciting way of living. People were drawn to their flexibility and affordability, but soon realized that furnishing them was a challenge. That's where our brand comes in - a brand born out of a need to provide stylish, adaptable, and practical furniture specifically designed for modular living.



Design Philosophy

Our brand is dedicated to providing stylish, adaptable, and practical furniture designed specifically for modular living—a perfect fusion of form and function tailored to meet the unique demands of your modern lifestyle. From the flexibility and ease of customization to the cost savings - modular furniture is quickly becoming one of the most popular options among homeowners.



Free Standing



MDF Material



Blum Mechanism

Materials



MDF MATERIAL Our Insta Furniture is crafted with excellence using Medium-Density Fiberboard (MDF). This versatile and durable material ensures the highest standards of quality and longevity for our furniture pieces.

Mechanism



BLUM MECHANISIM Effortless opening and closing, soft and silent closing action, and precise, smooth gliding of drawers & cabinets. With Blum Mechanism, our furniture provides a superior user experience, adding a touch of elegance and ease to your everyday life.

Colors



COLORS Our brand proudly presents different colors, a revolutionary line of furniture designed to perfectly complement the flexibility and versatility of modular living, tailored to your individual style and preferences.

Customize the color of millwork furniture



Plain Color
traffic white



Plain Color
champagne



Plain Color
chrome



Plain Color
terracota



Plain Color
midnight

Color of countertop



Quartz
bianco



Quartz
midnight

Design With our Mdolues



Discover our modular furniture collection featuring a variety of sizes and ranges. Mix and match modules to create personalized seating, storage, and entertainment solutions that adapt to your evolving needs. Embrace the freedom of customization and elevate your home with our versatile and stylish designs.



our modules

Unlock the power of customization and embrace the limitless possibilities of modular furniture. Design a living space that seamlessly adapts to your evolving needs and expresses your individual style. With our modular solutions, you have the freedom to transform your home into a personalized oasis that inspires and nurtures your daily life.

Modules vol.01

Our free-standing pieces offer easy mobility, allowing you to effortlessly rearrange your space to suit your changing needs. With no need for installation or attachment to walls, you can explore your creativity and transform your living areas with ease.

TALL MODULES

Module #001
Kitchen Cabinet

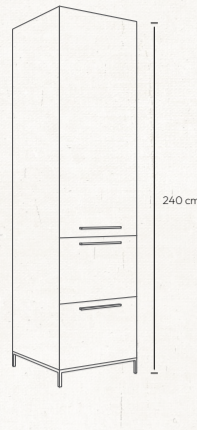

Materials:
MDF, Chipboard
Hinges:
Blum
Legs:
Stainless Steel

Module #002
Built in Refrigerator

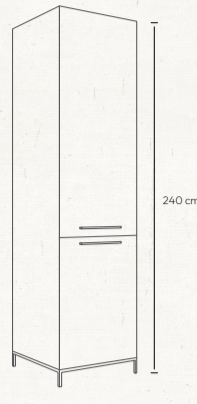

Materials:
MDF, Chipboard
Hinges:
Blum
Legs:
Stainless Steel

Module #003
Built in Refrigerator B

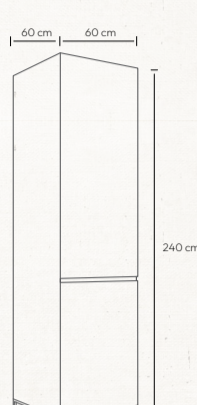

Materials:
MDF, Chipboard
Hinges:
Blum
Legs:
Stainless Steel

Module #004
Cabinet with Glass Door

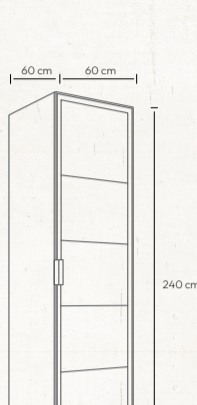

Materials:
MDF, Chipboard
Hinges:
Blum
Legs:
Stainless Steel

Module #005
Built in Microwave Cabinet

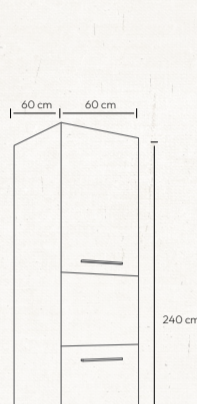

Materials:
MDF, Chipboard
Hinges:
Blum
Legs:
Stainless Steel

Module #006
Built in Oven Cabinet

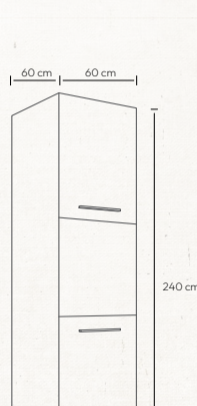

Materials:
MDF, Chipboard
Hinges:
Blum
Legs:
Stainless Steel

Module #007
Oven & Microwave Cabinet

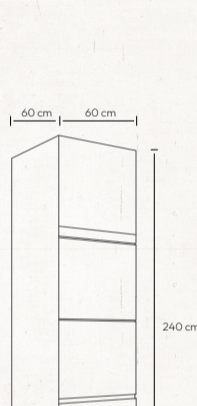

Materials:
MDF, Chipboard
Hinges:
Blum
Legs:
Stainless Steel

Module #008
Bedroom Cabinet B

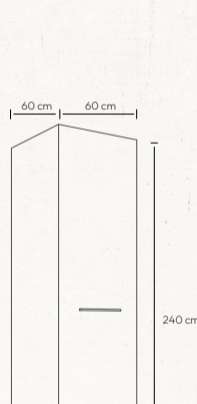

Materials:
MDF, Chipboard
Hinges:
Blum
Legs:
Stainless Steel

Module #009
Bedroom Cabinet with Glass

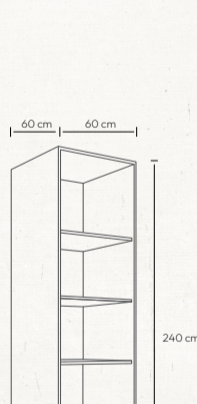

Materials:
MDF, Chipboard
Hinges:
Blum
Legs:
Stainless Steel

Module #010
Bedroom Cabinet A

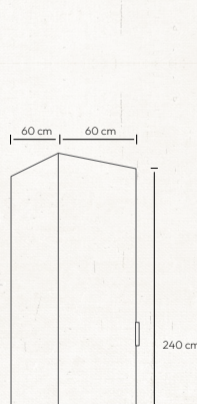

Materials:
MDF, Chipboard
Hinges:
Blum
Legs:
Stainless Steel

Module #011
Kitchen Cabinet

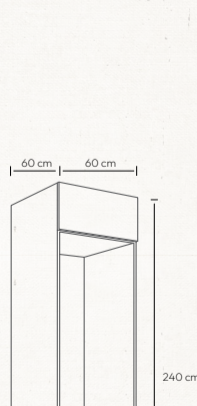

Materials:
MDF, Chipboard
Hinges:
Blum

Module #012
Kitchen Cabinet

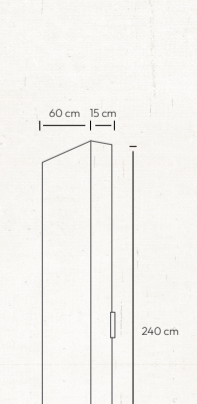

Materials:
MDF, Chipboard
Hinges:
Blum

Module #013
Kitchen Cabinet

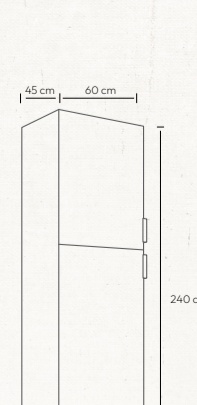

Materials:
MDF, Chipboard
Hinges:
Blum
Legs:
Stainless Steel

Modules vol.02

We understand that every individual has distinct tastes and requirements. That's why we offer a wide range of sizes and styles for you to choose from when customizing your furniture. Whether you prefer a compact and intimate set or a grand and spacious one, we have the perfect size options to accommodate your needs.

LOWER MODULES

Module #014
Kitchen



Materials:
MDF, Chipboard
Hinges:
Blum
Legs:
Stainless Steel

Module #015
Kitchen



Materials:
MDF, Chipboard
Hinges:
Blum
Legs:
Stainless Steel

Module #016
Kitchen



Materials:
MDF, Chipboard
Hinges:
Blum
Legs:
Stainless Steel

Module #017
Kitchen

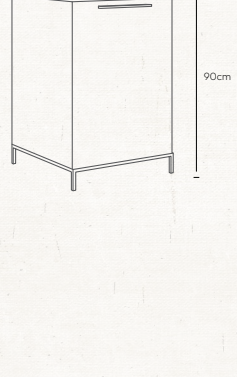
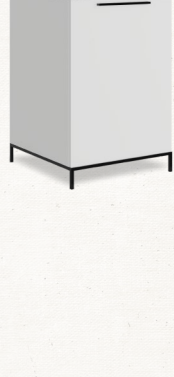

Materials:
MDF, Chipboard
Hinges:
Blum
Legs:
Stainless Steel

Module #018
Kitchen

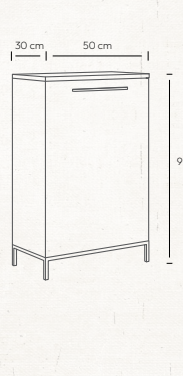

Materials:
MDF, Chipboard
Hinges:
Blum
Legs:
Stainless Steel

Module #019
Kitchen

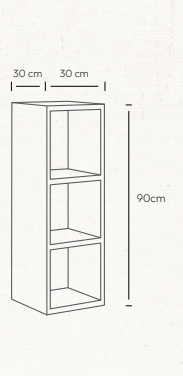

Materials:
MDF, Chipboard

Module #020
Kitchen



Materials:
MDF, Chipboard
Hinges:
Blum

Module #021
Kitchen



Materials:
MDF, Chipboard
Hinges:
Blum
Legs:
Stainless Steel

Module #022
Kitchen



Materials:
MDF, Chipboard
Hinges:
Blum
Legs:
Stainless Steel

Module #023
Kitchen

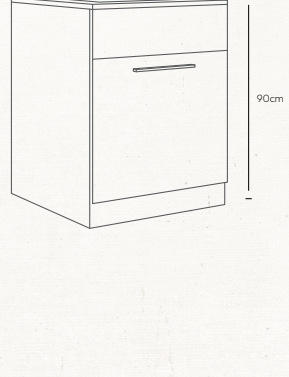
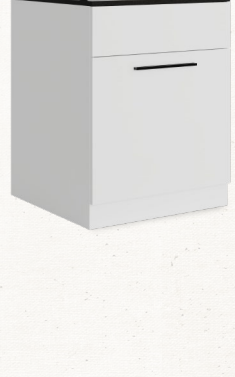

Materials:
MDF, Chipboard
Hinges:
Blum

Module #024
Kitchen

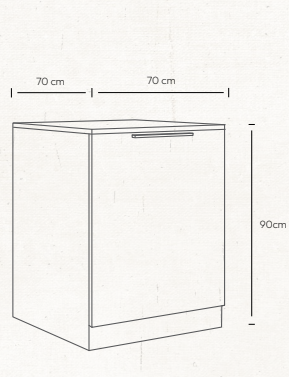
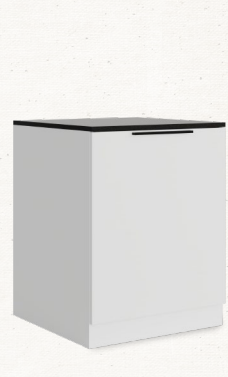

Materials:
MDF, Chipboard
Hinges:
Blum

Module #025
Kitchen

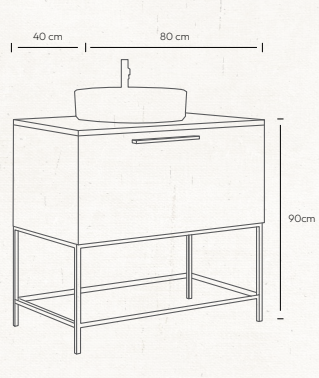

Materials:
MDF, Chipboard
Hinges:
Blum
Legs:
Stainless Steel

Module #026
Kitchen

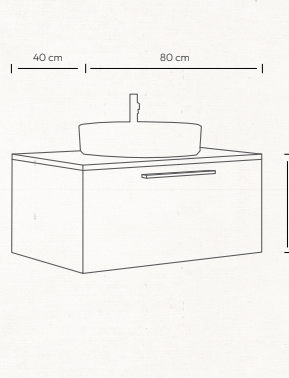

Materials:
MDF, Chipboard
Hinges:
Blum

Module #027
Kitchen

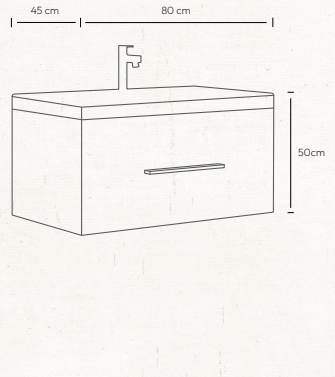

Materials:
MDF, Chipboard
Hinges:
Blum

Module #028
Kitchen

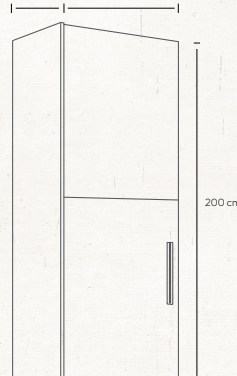

Materials:
MDF, Chipboard
Hinges:
Blum

Module #029
Kitchen

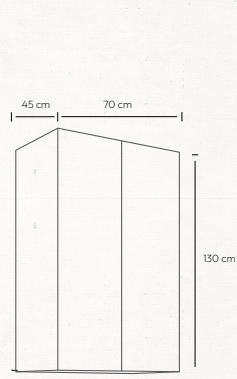
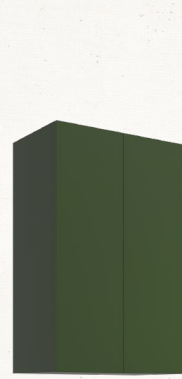

Materials:
MDF, Chipboard
Hinges:
Blum

Module #030
Kitchen

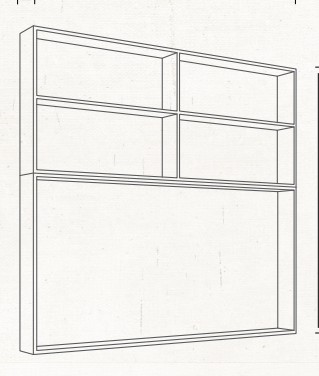

Materials:
MDF, Chipboard
Hinges:
Blum

Module #031
Kitchen

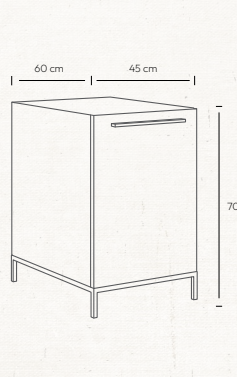

Materials:
MDF, Chipboard
Hinges:
Blum
Legs:
Stainless Steel

Module #032
Kitchen

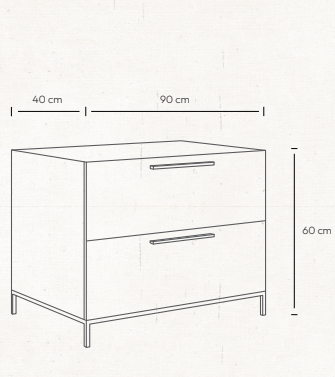

Materials:
MDF, Chipboard
Hinges:
Blum
Legs:
Stainless Steel

Module #033
Kitchen

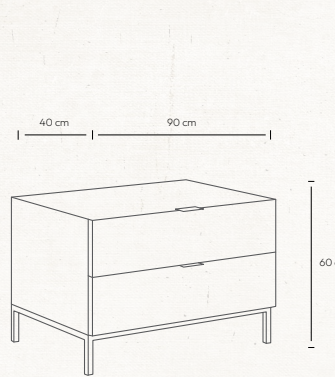

Materials:
MDF, Chipboard
Hinges:
Blum
Legs:
Stainless Steel

Module #034
Kitchen

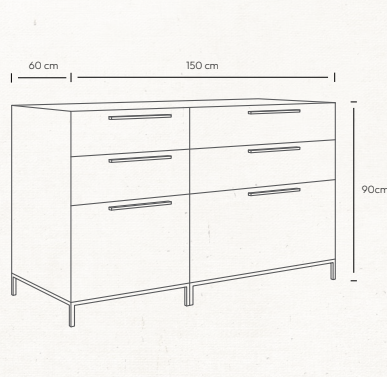

Materials:
MDF, Chipboard
Hinges:
Blum
Legs:
Stainless Steel

Modules vol.03

Experience the satisfaction of owning furniture that is not only functional but also a true reflection of your personality. The sleek and modern design seamlessly blends with any interior decor, making it the perfect addition to your home.

U P P E R M O D U L E S

Module #035
Kitchen

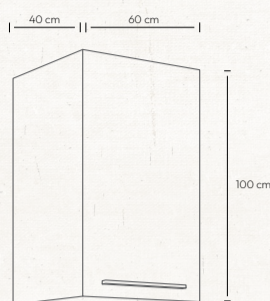
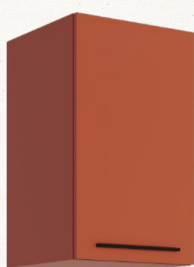

Materials:
MDF, Chipboard

Hinges:
Blum

Module #036
Kitchen

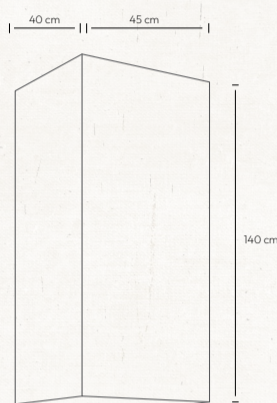
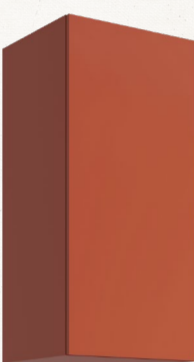

Materials:
MDF, Chipboard

Hinges:
Blum

Module #037
Kitchen

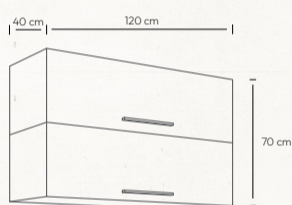

Materials:
MDF, Chipboard

Hinges:
Blum

Module #038
Kitchen

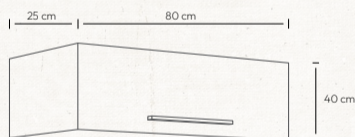

Materials:
MDF, Chipboard

Hinges:
Blum

Module #039
Kitchen

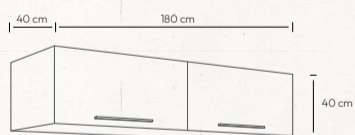

Materials:
MDF, Chipboard

Hinges:
Blum

Module #040
Kitchen

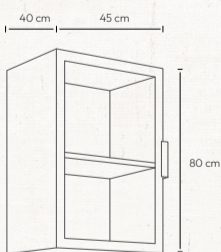

Materials:
MDF, Chipboard

Hinges:
Blum

Legs:
Stainless Steel

Module #041
Kitchen

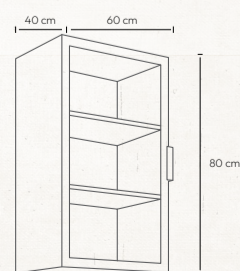

Materials:
MDF, Chipboard

Hinges:
Blum

Legs:
Stainless Steel

Modules vol.04

Each item is meticulously crafted with utmost attention to detail, ensuring both durability and aesthetic appeal. Whether you seek a chic and minimalistic look or a bold and vibrant style, Insta Furniture offers an extensive selection to suit your preferences.

RACK MODULES

Module #042
Kitchen

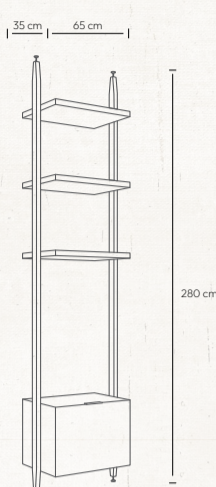

Materials:
MDF, Chipboard

Hinges:
Blum

Legs:
Stainless Steel

Module #043
Kitchen

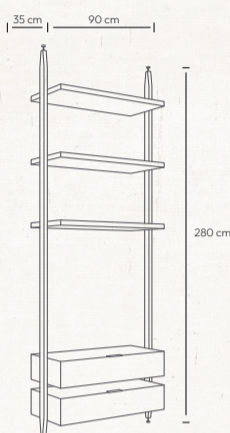

Materials:
MDF, Chipboard

Hinges:
Blum

Legs:
Stainless Steel

Module #044
Kitchen

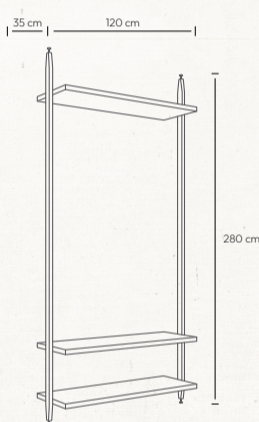
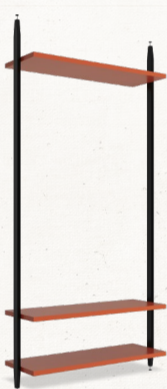

Materials:
MDF, Chipboard

Legs:
Stainless Steel

Module #045
Kitchen

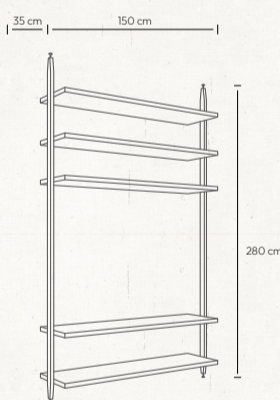
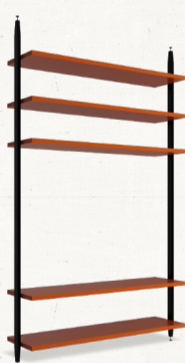

Materials:
MDF, Chipboard

Legs:
Stainless Steel

Module #046
Kitchen

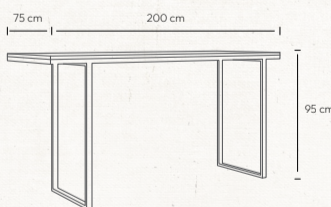

Materials:
Wood, Chipboard

Legs:
Stainless Steel

Module #047
Kitchen

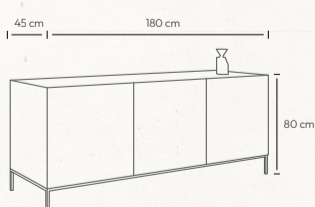

Materials:
MDF, Chipboard

Hinges:
Blum

Legs:
Stainless Steel

Module #048
Kitchen

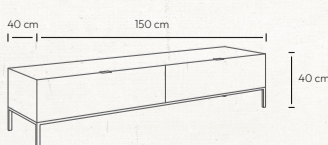
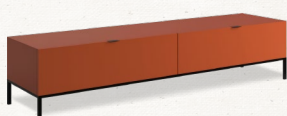

Materials:
MDF, Chipboard

Hinges:
Blum

Legs:
Stainless Steel

explore

Elevate your home decor to new heights and immerse yourself in the world of modular design with Insta Furniture - where style meets versatility.

Black & Orange Kitchen

This kitchen is built with black cabinets with orange accents. The cabinets are crafted in a combination of materials such as MDF, glass, and steel. MDF can be used for the cabinet doors and drawers, and steel for the countertops and backsplashes. This combination creates a bold and modern look, perfect for any modern kitchen.

KITCHEN MODULES



Champagne Kitchen

The white and champagne color scheme gives a bright and fresh look. These pieces fit together seamlessly, lasting a lifetime. The high-quality cabinets are durable and stylish, and the countertops provide a modern finish.

KITCHEN MODULES



White & Orange Kitchen

Sleek and sophisticated design with white cabinets and stainless steel accents. The glossy white cabinets provide a clean and timeless look, while the stainless steel handles and appliances add a touch of modernity.

KITCHEN MODULES



Champagne & Black Kitchen

Contemporary and calming atmosphere with a modular kitchen in soothing shades of black. The soft black cabinets evoke a sense of tranquility, while the light-colored countertops and backsplash create a fresh and airy feel.

KITCHEN MODULES



Black & Green Kitchen

For a sleek and modern kitchen, opt for a modular design with black cabinets. The black cabinetry exudes sophistication and pairs beautifully with stainless steel appliances and minimalist hardware.

KITCHEN MODULES



Black & Green Kitchen

This monochromatic color scheme creates a contemporary and polished aesthetic. This color palette is perfect for those seeking a serene and inviting kitchen space.

KITCHEN MODULES



Black Wooden Kitchen

Create a warm and inviting ambiance with a modular kitchen in rich wooden tones. The natural wood cabinets exude elegance and provide a cozy and timeless look.

KITCHEN MODULES



cabients

Modular homes were a new and exciting way of living.
People were drawn to their flexibility and affordability,

Champagne Wardrobe

The champagne gray color adds a unique twist to traditional gray cabinets, creating a subtle and refined aesthetic. Create a bright and fresh open space with modular cabinets in light champagne.

CABIENT MODULES



Champagne Cabinet

The light champagne color brings a sense of freshness and openness to the room. Combine them with white countertops and light wood accents for a chic and airy atmosphere.

CABINET MODULES



Champagne Cabinet

The warm and soft champagne hue creates a luxurious and inviting atmosphere. Add a touch of elegance to your bedroom with modular cabinets in champagne gold.

CABIENT MODULES



Black Cabinet

Create a refined and luxurious bedroom with a modular design in shades of black. The black cabinets exude elegance and versatility, providing a neutral backdrop for various design styles.

CABIENT MODULES



Black Wardrobe

The black cabinets exude elegance and pair beautifully with stainless steel hardware and appliances, creating a contemporary and luxurious wardrobe design.

CABIENT MODULES



Black Wardrobe

The matte finish adds a touch of modernity and complements a minimalist aesthetic. Pair them with contrasting white countertops and backsplashes for a striking monochromatic look.

CABIENT MODULES



Elegant & Functional Fusion

Crafted with meticulous attention to detail, TV Stand combines style and practicality seamlessly. Its clean lines and minimalist design make it a perfect complement to any contemporary or transitional interior decor.

C A B I E N T M O D U L E S



Lore
m
ipsu
m
dolo

Beauty & Function

Our wardrobes not only offer practical storage solutions but also serve as stunning centerpieces in your room. From luxurious finishes to elegant hardware, every detail is carefully chosen to elevate the overall aesthetic of your space.

CABIENT MODULES



Black Bathroom

Create a dramatic and stylish bathroom with modular cabinets in black lacquer. The glossy finish adds depth and visual interest, while the black color lends a sense of sophistication.

CABIENT MODULES



White Bathroom

The white cabinets exude elegance and purity, providing a fresh and clean aesthetic. Pair them with marble countertops and silver hardware for a classic and sophisticated look.

CABINET MODULES

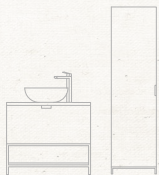

White Bathroom

Pairing the blue hues with sleek white fixtures and accents adds a touch of elegance and sophistication. With the combination of soft colors, such as seafoam or aqua, and modern elements, you can create a bathroom that exudes a sense of tranquility and timeless beauty.

CABIENT MODULES



Golden Elegance

With their subtle golden undertones, these cabinets add a sense of warmth and richness to the space. The Champagne hue beautifully complements a variety of bathroom styles, from contemporary to traditional, enhancing the overall aesthetic appeal.

CABIENT MODULES



Green & Black

Elevate your bathroom design with the captivating combination of green cabinets and black marble. Immerse yourself in the tranquility of nature-inspired hues while indulging in the luxurious beauty of black marble.

CABIENT MODULES



racks

Modular homes were a new and exciting way of living.
People were drawn to their flexibility and affordability,

Black Racks

The black cabinets bring a sense of fun and creativity to the space, infusing it with personality. Pair them with bright mosaic tiles and open shelving for a vibrant and eclectic aesthetic.

RACK MODULES



Orange Racks

Add a burst of energy and warmth to your kitchen with modular cabinets in vibrant orange. The bold orange cabinets create a cheerful and lively atmosphere, making a statement in any kitchen.

RACK MODULES

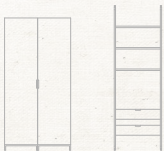

Green Racks

The green cabinets create a calming and soothing ambiance, reminiscent of a serene garden. Create a sophisticated and earthy kitchen with modular cabinets in olive green.

RACK MODULES



Green Racks

Indulge in the sophisticated and earthy tones, bringing a touch of nature indoors for a truly captivating kitchen space. Transform your kitchen into a tranquil oasis with modular cabinets in serene olive green.

RACK MODULES



Green Racks

Elevate your living room to a serene oasis with modular cabinets in elegant olive green. These cabinets infuse your space with a calming and soothing ambiance, reminiscent of a peaceful garden.

RACK MODULES



others

Stand apart from the ordinary and embrace the extraordinary with our collection of high-quality, one-of-a-kind furniture.

Style & Glamour

Create a luxurious and inviting atmosphere in your home with the timeless elegance of a leather sofa and marble table. Embrace the comfort of leather and the captivating allure of marble, and indulge in a living space that exudes sophistication and style.

OTHER MODULES



Comfort & Brilliance

The leather sofa and table combination not only adds a touch of luxury to your space but also enhances its functionality. The sturdy construction and ergonomic design of the sofa offer maximum comfort, allowing you to unwind and rejuvenate.

OTHER MODULES



Bespoke & Stylish

At Insta Furniture, we believe in providing you with endless possibilities for customization. Our White Boucle Sofa is no exception. Not only does it exude elegance and comfort, but it also offers a wide range of customization options to suit your unique preferences.

OTHER MODULES



Graceful & Sleek

Our collection features exquisite pieces like the black boucle armchair and glass table, designed to elevate your living space to new heights of elegance. Elevate your interior design to new levels of sophistication and immerse yourself in the unparalleled beauty.

OTHER MODULES

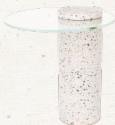

Limitless & Exceptional

Discover a world of endless possibilities and impeccable quality with our extensive collection of beds. With an array of styles, sizes, and designs, we offer a vast selection that caters to every taste and preference.

OTHER MODULES



Modern & Cozy

Create a cozy reading nook in your living room, add a statement piece to your bedroom, or enhance your office space with our versatile collection. At Insta Furniture, we invite you to elevate your space and enjoy the timeless elegance and functionality of our armchairs and tables.

OTHER MODULES



Sleek & Relaxing

Choose from an array of materials, colors, and table finishes to create a personalized look that perfectly reflects your style and taste. Whether you prefer a sleek and modern design or a classic and timeless silhouette, our armchairs and tables are available in a variety of styles to suit your taste.

OTHER MODULES



Unique & Style

At Insta Furniture, we understand the importance of customization. That's why many of our dining tables offer options for finishes, colors, and sizes, allowing you to create a table that is uniquely yours.

OTHER MODULES



Infinite & Premium

Experience the joy of a good night's sleep and the satisfaction of owning a high-quality bed that reflects your individuality. Explore the boundless possibilities and transform your bedroom into a sanctuary of relaxation and style.

OTHER MODULES



 INSTABUILT

the future of living

sales@instabuilt.com

+383 38 600 615 / +49 72 312 059 970

www.instabuilt.com

Prishtina - Mitrovica Highway KM12
Milloseve, Obiliq, 10000 Kosova